

		Technical Data Sheet				
Project		Location United Arab Emirates				
Company Trielectric International FZE		Contact Mr.Saravanan(+971564345964)		Contact Mr.Thamizh(+971502353763)		
Our ref. Stock		Rev/Changed by A		Date of issue 9/14/2021		
		Saving ident		Item name 1.00016		
				Pages 1(3)		
No.	Definition	Data	Unit	Remarks		
1	Product	TEFC, 3-phase, squirrel cage induction motor				
2	Product code	3GBA 222 210-ADCIN		Calc. ref.	3GZH021022-2	
3	Type/Frame	M2BAX 225SMA 4				
4	Mounting	IM1001, B3(foot)				
5	Rated output P _N	37	kW			
6	Service factor	1				
7	Type of duty	S1 100%				
8	Rated voltage U _N	400	VD	± 5 %		
9	Rated frequency f _N	50	Hz	± 2 %		
10	Rated speed n _N	1475	r/min			
11	Rated current I _N	69	A			
12						
13	Starting current I _s /I _N	6.5				
14	Nominal torque T _N	240	Nm			
15	Locked rotor torque T _s /T _N	2.1				
16	Maximum torque T _{max} /T _N	2.7				
17						
18						
Load characteristics		Load %	Current A	Efficiency %	Power factor	
19	PLL determined from residual loss	100	69	92.7 / IE2	0.84	
20		75	53.1	93.1	0.81	
21		50	39.1	92.2	0.74	
22						
23	Thermal withstand time hot	17	s			
24	Thermal withstand time cold	28	s			
25	Insulation class / Temperature class	F / B				
26	Ambient temperature	50				
27	Altitude	1000	m.a.s.l.			
28	Degree of protection	IP55				
29	Cooling system	IC411				
30	Bearing DE/NDE	6313-2Z/C3 - 6210-2Z/C3				
31	Sound pressure level (LP dB(A) 1m)	80	dB(A)	at no-load		
32	Moment of inertia J = ¼ GD2	0.3605	kg-m2			
33	Position of terminal box	Top				
34	Direction of rotation	Bi-directional				
35	Weight of rotor	84	kg			
36	Total weight of motor	267	kg			
37	Paint shade	Munsell Blue				
38	Cable size					
39	Vibration	As Per IS 12075				
40						
41						
42						
43						
44						
45						
Ex-motors						
46						
47						
48						
Option Variant Codes / Definition						
49						
50						
51						
52						
Remarks:						
Applicable standards: IS 12615:2018, IEC 60034-30-1:2014						

All performance values are subject to IS/IEC tolerances

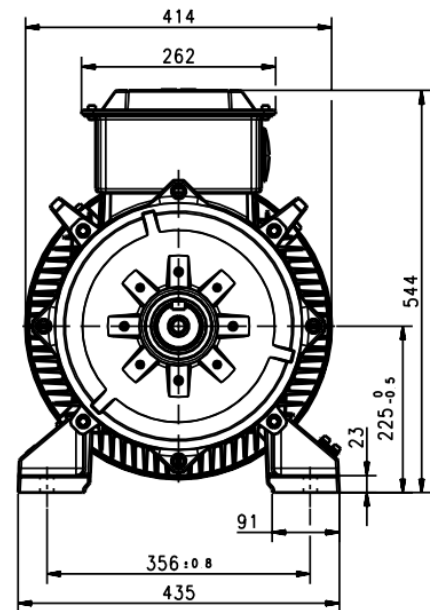
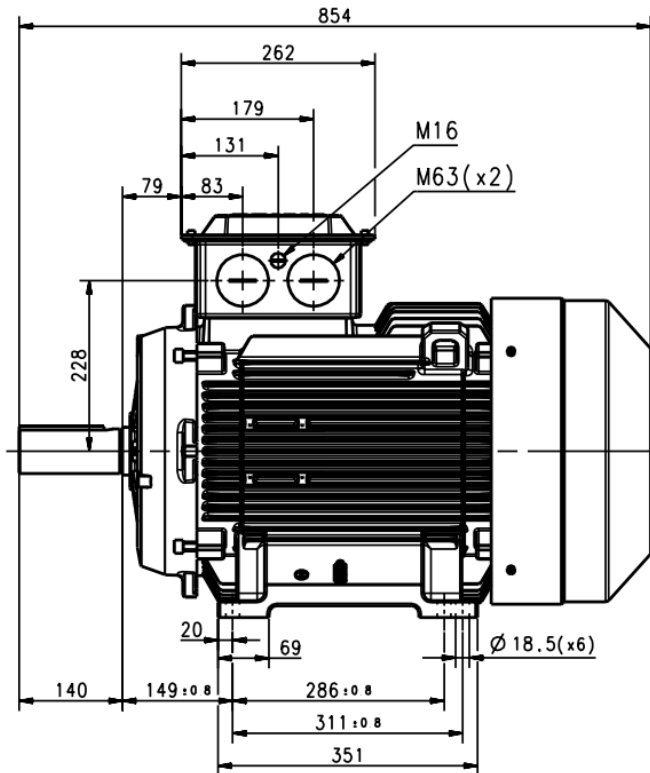
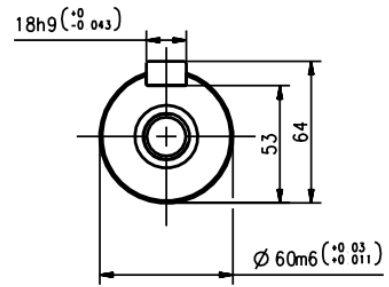
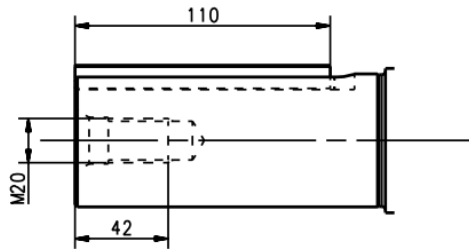
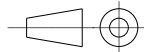

Additional information:

Dimension Print	Motor Type:	IE2&IE1 M2BAX 225SM_4-6 B3, B6, B7, B8, V5, V6	Document No:	3GZC500022-6 F
		IE3 M2BAX 225SM_4-6 B3, B6, B7, B8, V5, V6		13 BA 225 A
Description: STANDARD SQUIRREL CAGE MOTOR				
Unit:	ABB Motors and Generators	Issued by:	Jeff Wang	Replaces:
Date:	2019-07-05	Approved by:	Adam Zhu	Replaced by:
ABB Ltd.		Customer Reference:		

Motors in brief

General performance IE2 high efficiency cast iron motors

Size	160	180	200	225	250	
Stator	Material	Cast iron grade 200 : ISO 185				
	Paint colour shade	Munsell blue 8B 4.5/3.25 / NCS 4822 B05G				
	Surface Treatment	C3 medium according to ISO / EN 12944-5				
Feet		Integrated with stator				
	Material	Cast iron grade 200 : ISO 185				
Bearing end shields	Material	Cast iron grade 200 : ISO 185				
	Paint colour shade	Munsell blue 8B 4.5/3.25 / NCS 4822 B05G				
	Surface Treatment	Aliphatic polyurethane enamel paint_70µm				
Bearings	D-end	6209-2Z/C3	6310-2Z/C3	6312-2Z/C3	6313-2Z/C3	6315-2Z/C3
	N-end	6209-2Z/C3	6209-2Z/C3	6209-2Z/C3	6210-2Z/C3	6212-2Z/C3
Axially-locked	Inner Bearing Cover	As standard, locked at D-end				
Bearing seals	D-end	V-ring				
	N-end	V-ring				
Lubrication		Permanently lubricated shielded bearings				
Terminal Box	Material	Sheet of Steel, Cold Rolled				
	Surface	Treatment Similar to stator				
	Screws	Steel 8.8				
Connections	Cable Entries	2xM40, 1xM16			2xM50, 1xM16	
	Cable Sizes	2Rx3Cx70mm ²			2Rx3Cx120mm ²	
	Terminal Stud Size	M6			M10	
	Terminal Box	6 terminals for connection, cable lugs (not included)				
Fan	Material	Polypropylene, Reinforced with 20% glass fibre				
Fan Cover	Material	Sheet of Steel, Cold Rolled				
	Paint colour shade	Munsell blue 8B 4.5/3.25 / NCS 4822 B05G				
	Surface Treatment	Similar to stator				
Stator winding	Material	Copper				
	Insulation	Insulation class F				
Rotor winding	Material	Diecast aluminum				
Balancing method		Half Key Balancing as standard				
Key ways		Open Key Way				
Enclosure		IP 55				
Cooling method		IC 411				
Drain holes		Drain holes with closable plastic plugs, open on delivery				
Lifting lugs		Integrated with the stator				