

IEC LV Motors		Technical Data Sheet			
		Project	Location		
Department/Author Gugan E		Customer name	Customer ref		Item name 1.00004
Our ref. Trielectric International FZE		Rev/Changed by A	Date of issue 9/25/2023	Saving ident untitled.xlsm	Pages 1(3)
No.	Definition	Data	Unit	Remarks	
1	Product	TEFC, 3-phase, squirrel cage induction motor			
2	Product code	3GBA 203 420-ADDIN		Calc. ref.	3GZH021020-23
3	Type/Frame	M2BAX 200MLB 6			
4	Mounting	IM1001, B3(foot)			
5	Rated output P _N	22	kW		
6	Service factor	1			
7	Type of duty	S1 100%			
8	Rated voltage U _N	400	VD		± 5 %
9	Rated frequency f _N	50	Hz		± 2 %
10	Rated speed n _N	986	r/min		
11	Rated current I _N	43.9	A		
12					
13	Starting current I _s /I _N	7.5			
14	Nominal torque T _N	213	Nm		
15	Locked rotor torque T _s /T _N	2.3			
16	Maximum torque T _{max} /T _N	3.1			
17					
18					
Load characteristics		Load %	Current A	Efficiency %	Power factor
19	PLL determined from residual loss	100	43.9	92.2 / IE3	0.79
20		75	35.4	92.2	0.73
21		50	28.1	91.1	0.62
22					
23	Thermal withstand time hot	11	s		
24	Thermal withstand time cold	18	s		
25	Insulation class / Temperature class	F / B			
26	Ambient temperature	50	°C		
27	Altitude	1000	m.a.s.l.		
28	Degree of protection	IP55			
29	Cooling system	IC411			
30	Bearing DE/NDE	6312-2Z/C3 - 6209-2Z/C3			
31	Sound pressure level (LP dB(A) 1m)	80	dB(A)		at no-load
32	Moment of inertia J = ¼ GD2	0.585	kg-m2		
33	Position of terminal box	Top			
34	Direction of rotation	Bi-directional			
35	Weight of rotor	98	kg		
36	Total weight of motor	263	kg		
37	Paint shade	Munsell Blue			
38	Cable size				
39	Vibration	As Per IS 12075			
40					
41					
42					
43					
44					
45					
Ex-motors					
46					
47					
48					
Option Variant Codes / Definition					
49					
50					
51					
52					
Remarks:					
Applicable standards: IS 12615:2018, IEC 60034-30-1:2014					

All performance values are subject to IS/IEC tolerances

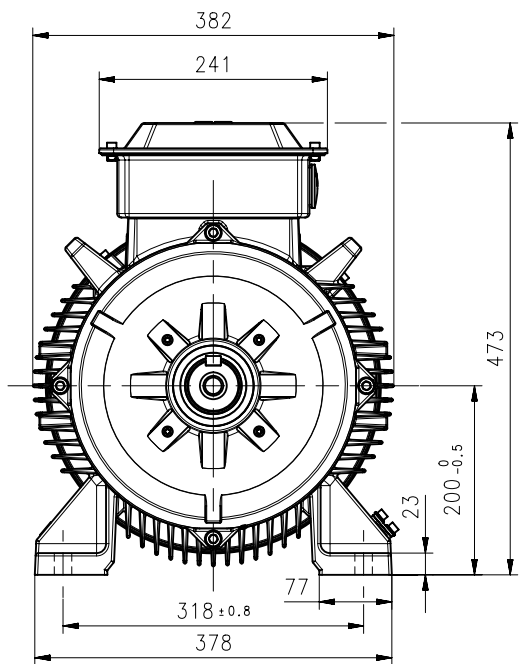
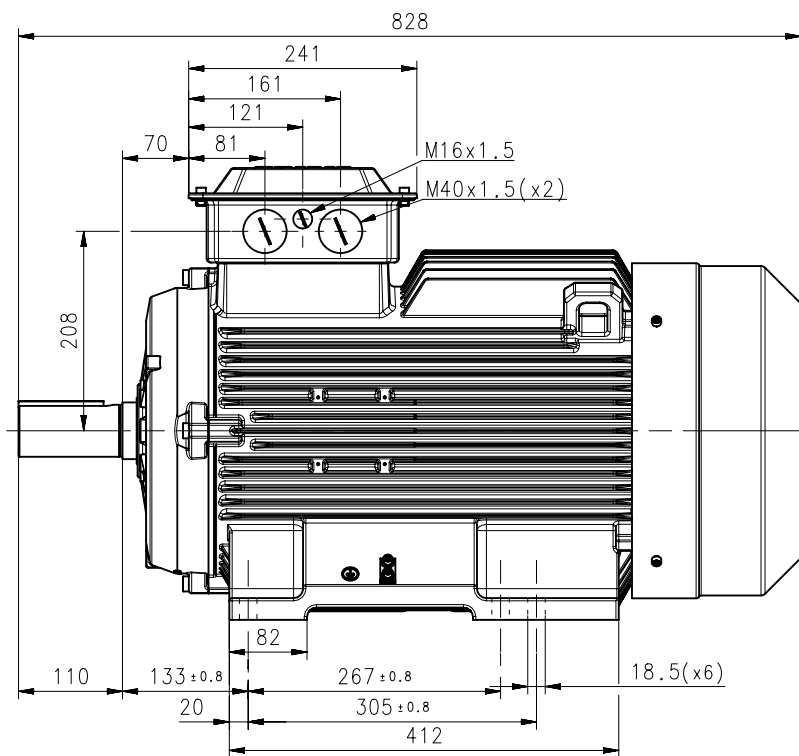
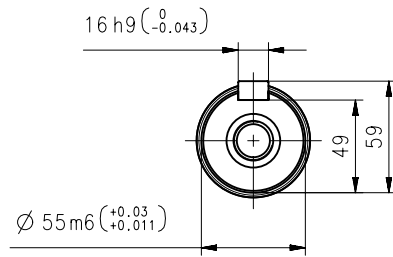
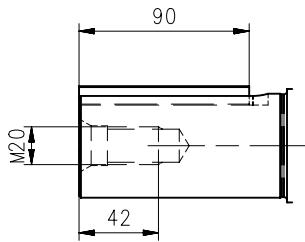

Additional information:

Dimension Print	Motor type: IE3 M2BAX 200MLA2/MLB2/MLA4/MLB6/MLA8 B3, B6, B7, B8, V5, V6	Document No: 3GZC500020-39 C
------------------------	---	---------------------------------

Description: STANDARD SQUIRREL CAGE MOTOR

Unit: IEC LV Motors
Date: 17-Aug-2022

Issued by: Winifred Zi
Approved by: Serena Wang

Replaces:
Replaced by:



Customer Reference:

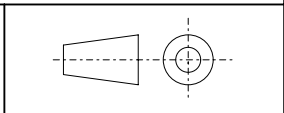

Motors in brief

General performance IE3 premium efficiency cast iron motors in brief

Size	160	180	200	225	250	
Stator	Material	Cast Iron Grade 200:ISO 185				
	Paint colour shade	Munsell blue 8B 4.5/3.25 / NCS 4822 B05G				
	Surface Treatment	C3 medium according to ISO / EN 12944-5				
Feet		Integrated with stator				
	Material	Cast iron grade 200 : ISO 185				
Bearing end shields	Material	Cast iron grade 200 : ISO 185				
	Paint colour shade	Munsell blue 8B 4.5/3.25/NCS 4822 B05G				
	Surface Treatment	C3 medium according to ISO / EN 12944-5				
Bearings	D-end	6209-2Z/C3	6310-2Z/C3	6312-2Z/C3	6313-2Z/C3	6315-2Z/C3
	N-end	6209-2Z/C3	6209-2Z/C3	6209-2Z/C3	6210-2Z/C3	6212-2Z/C3
Axially-locked	Inner Bearing Cover	As standard, locked at D-end				
Bearing seals		Axial seal standard, radial on request				
Measuring nipple		Not included				
Lubrication		Permanently lubricated shielded bearings				
Rating plate	Material	Aluminium				
Terminal Box	Frame material	Sheet of Steel, cold rolled				
	Cover material	Sheet of Steel, cold rolled				
	Cover screws material	Steel 8.8				
Connections	Cable entries	2xM40, 1xM16		2xM50, 1xM16		
	Cable Sizes	2Rx3Cx70mm ²		2Rx3Cx120mm ²		
	Terminal Stud Size	M6		M10		
	Terminals	6 terminals for connection, cable lugs (not included)				
Fan	Material	Polypropylene, Reinforced with 20% glass fibre				
Fan Cover	Material	Sheet of steel, cold rolled				
	Paint Colour shade	Munsell blue 8B 4.5/3.25/NCS 4822 B05G				
	Surface Treatment	C3 medium according to ISO/EN 12944-5				
Stator winding	Material	Copper				
	Insulation	Insulation class F, Temperature rise class B unless otherwise stated.				
	Winding protection	-				
Rotor winding	Material	Pressure diecast aluminium				
Balancing method		Half Key Balancing as Standard				
Key ways		Open Key Way				
Enclosure		IP 55, Higher protection on request				
Cooling method		IC 411				
Drain holes		Drain holes with closable plastic plugs, open on delivery				
Lifting lugs		Integrated with the stator				