

Motors don't just fail...do they? A guide to preventing failure

Next >

Why motors fail

Contents

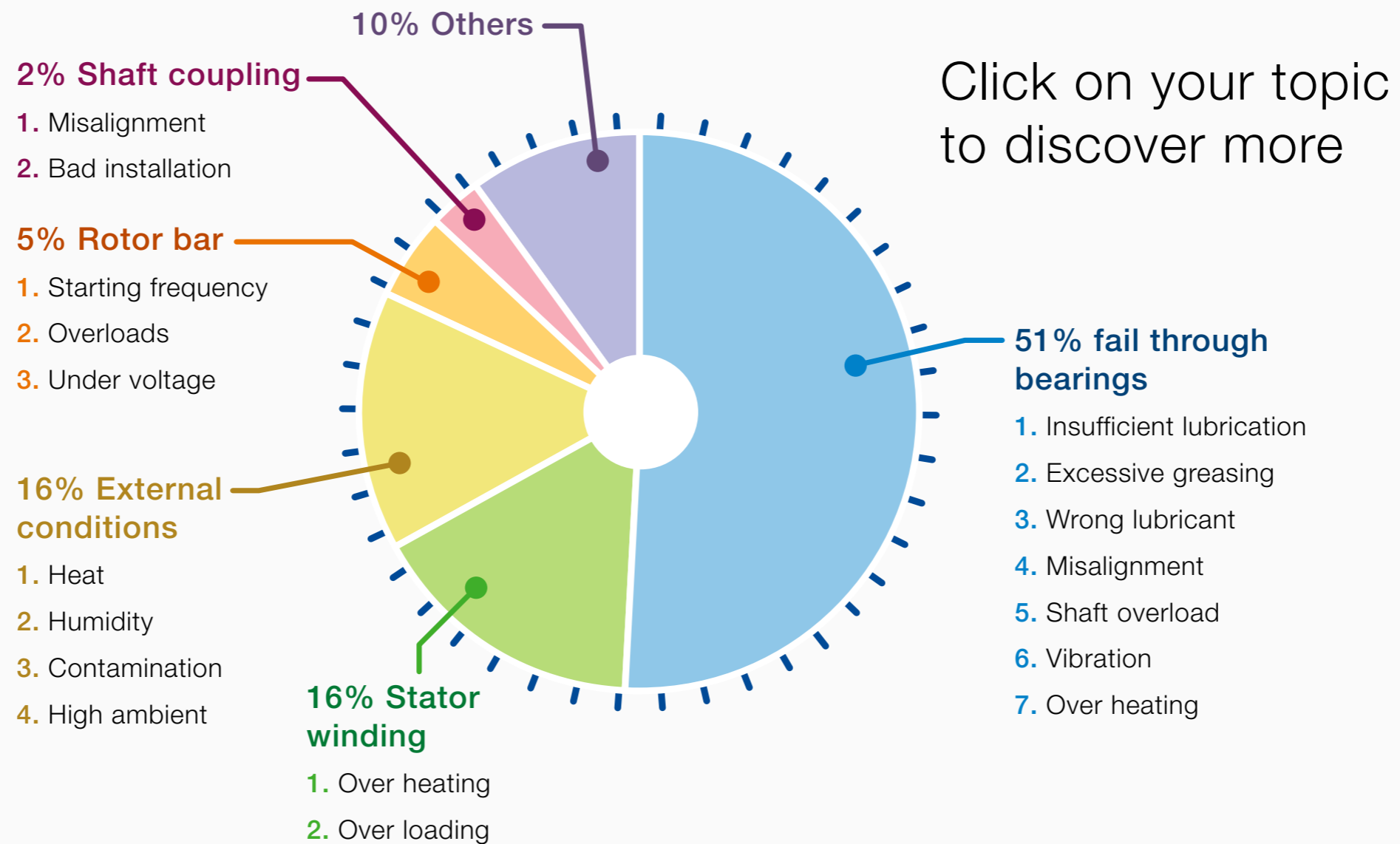

Bearing failure The facts

Motors don't fail just because
of age or operating hours...

51% of failures
are **bearing** related*

*Based on IEA data



[Table of contents](#)

[Next >](#)

3/70

Reasons why 51% of motors fail through bearings

1. Insufficient lubrication

Re-greasable bearings need regular maintenance...
...don't fit and forget...for example...

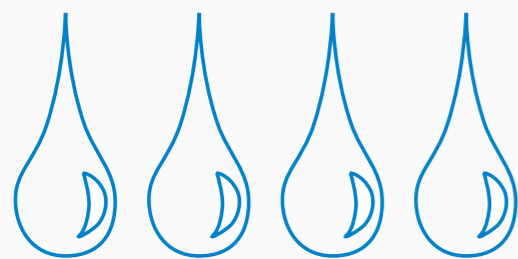

approx.
every

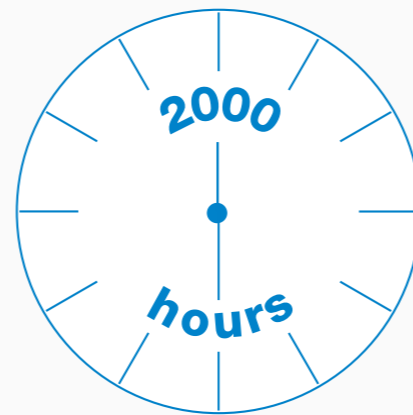

or

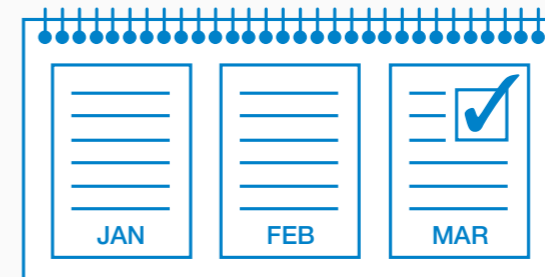

3 months



[Table of contents](#)

[< Back](#)

[Technical](#)

[Tips](#)

[FAQs](#)

[Next >](#)

4/70

Technical

1. Insufficient lubrication

Refer to the manufacturer operation and maintenance manual for specific re-lubrication intervals for your motor.

Low voltage Motors for explosive atmospheres
Installation, operation, maintenance and safety manual



Installation, operation, maintenance and safety manual	EN 3
Montage-, Betriebs-, Wartungs- und Sicherheitsanleitung	DE 27
Manuel d'installation, d'exploitation, de maintenance et de sécurité	FR 51
Manual de instalación, funcionamiento, mantenimiento y seguridad	ES 75
Manuale d'installazione, funzionamento e manutenzione	IT 99
Manual de instalação, operação, manutenção e segurança	PT 123

More languages – see web site www.abb.com/motors&generators > Motors > Document library

Power and productivity
for a better world™ **ABB**

[Click here to download](#)

Low voltage motors
Installation, operation, maintenance and safety manual



Installation, operation, maintenance and safety manual.....	EN 3
Montage-, Betriebs-, Wartungs- und Sicherheitsanleitung.....	DE 21
Manuel d'installation, d'exploitation, de maintenance et de sécurité.....	FR 41
Manual de instalación, funcionamiento, mantenimiento y seguridad.....	ES 61
Manuale d'installazione, funzionamento e manutenzione.....	IT 81
Manual de instalação, operação, manutenção e segurança.....	PT 101
Installations-, drifts-, underhålls- och säkerhetsmanual.....	SV 123
Asennus-, käyttö-, kunnossapito- ja turvallisuusohje.....	FI 141

More languages – see web site www.abb.com/motors&generators > Motors > Document library

Power and productivity
for a better world™ **ABB**

[Click here to download](#)



[Table of contents](#)

[< Back](#)

[Tips](#)

[FAQs](#)

[Next >](#)

Tips

1. Insufficient lubrication

Look for this plate on your motor...
...it gives you the detail you need
to re-grease your motor bearings.

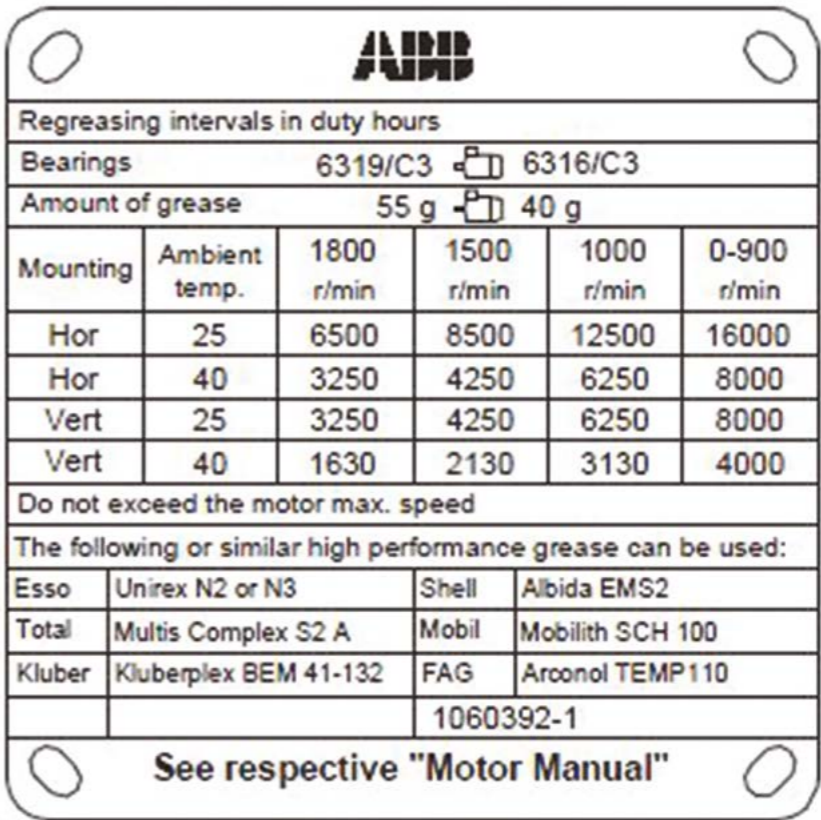

ABB

Regreasing intervals in duty hours

Bearings 6319/C3  6316/C3

Amount of grease 55 g  40 g

Mounting	Ambient temp.	1800 r/min	1500 r/min	1000 r/min	0-900 r/min
Hor	25	6500	8500	12500	16000
Hor	40	3250	4250	6250	8000
Vert	25	3250	4250	6250	8000
Vert	40	1630	2130	3130	4000

Do not exceed the motor max. speed

The following or similar high performance grease can be used:

Esso	Unirex N2 or N3	Shell	Albida EMS2
Total	Multis Complex S2 A	Mobil	Mobilith SCH 100
Kluber	Kluberplex BEM 41-132	FAG	Arconol TEMP110
			1060392-1

See respective "Motor Manual"



Table of contents

< Back

Technical

FAQs

Next >

6/70

FAQ

1. Insufficient lubrication

Do I have to re-grease sealed for life bearings?

No, these bearings are permanently greased (sealed for life) and can not be re-greased

Power and productivity
for a better world™ **ABB**

Variant code: 194
ZZ bearings greased for life at both ends.

This includes bearings greased for life in both the drive and non-drive end of the motor.
A grease for life bearing means that the grease and rolling elements of the bearing are encapsulated and the bearing can't be re-greased.

The ZZ bearings are closed by a metal shield on both sides of the bearing (see picture below).
The double side shield design protects against entry of dirt and particles and keeps the grease in the bearing.

Other types of greased for life bearings are 2RS bearings that are protected with rubber seals instead of metal shields.

If a bearing with a suffix of 1Z is only sealed on one side, and the applies to 1RS bearings.

Picture of bearing with shields (ZZ)



We reserve all rights in this document and in the subject matter and illustrations contained therein.
Any reproduction, disclosure to third parties or utilization of its contents - in whole or in parts - is forbidden without prior written consent of ABB.
Copyright 2014 ABB

[Click here to download](#)



[Table of contents](#)

[< Back](#)

[Technical](#)

[Tips](#)

[Next >](#)

7/70

Reasons why 51% of motors fail through bearings

2. Excessive greasing

Yes this can overheat bearings and lead to failure.

Ensure grease relief valves are open during the re-greasing process to allow excess grease to purge from the bearing housing.



[Table of contents](#)

[< Back](#)

[Tips](#)

[FAQs](#)

[Next >](#)

8/70

Tips

2. Excessive greasing

A bearing lip seal will typically fail at 500 psi, yet grease guns can produce up to 1500 psi

Add each shot of grease slowly to avoid pressure build-up



[Table of contents](#)

[< Back](#)

[FAQs](#)

[Next >](#)

9/70

FAQ

2. Excessive greasing

What is the best way to control over-greasing?

1. Always make sure relief valves are cleaned out of any dirt or hardened grease
2. Remove grease outlet plug or open outlet valve where fitted
3. Slowly pump grease into the bearings every few seconds (avoid quick-lever actions as pressure will build and damage seals)
4. Discontinue greasing if any abnormal back pressure is felt



[Table of contents](#)

[< Back](#)

[Tips](#)

[Next >](#)

10/70

Reasons why 51% of motors fail through bearings

3. Wrong lubricant

Check that you are using the right grade or type of grease.

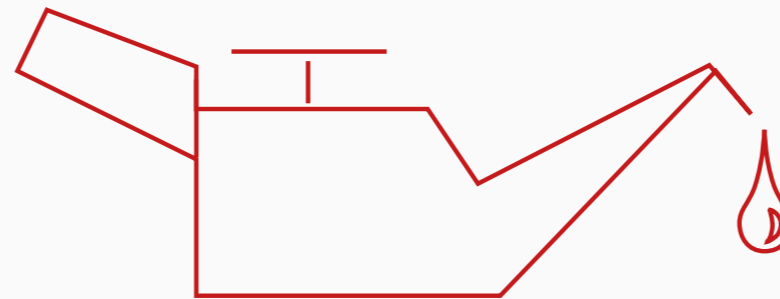
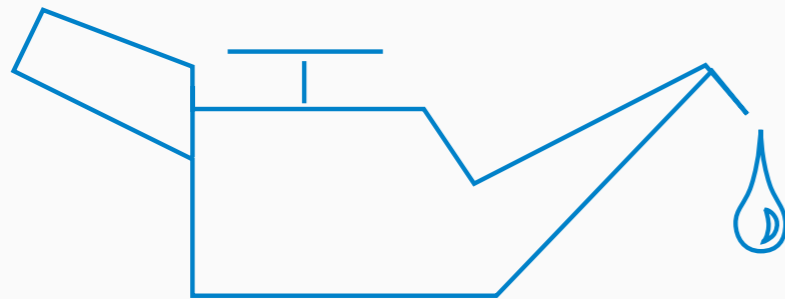

Technical

3. Wrong lubricant

When re-greasing, use only special ball bearing grease with the following properties:

- Good quality grease with lithium complex soap and with mineral or PAO-oil
- Base oil viscosity 100-160 cST at 40°C
- Consistency NLGI grade 1.5 - 3
- Temperature range -30°C - +120°C, continuously.

Refer to the lubricants section of your motor operations manual.

6.2.4 Lubricants

WARNING
Do not mix different types of grease.
Incompatible lubricants may cause bearing damage.

When regreasing, use only special ball bearing grease with the following properties:

- good quality grease with lithium complex soap and with mineral- or PAO-oil
- base oil viscosity 100-160 cST at 40°C
- consistency NLGI grade 1.5 - 3 *)
- temperature range -30°C - +120°C, continuously.

*) For vertical mounted motors or in hot conditions a stiffer end of scale is recommended.

The above mentioned grease specification is valid if the ambient temperature is above -30°C or below +55°C, and the bearing temperature is below 110°C; otherwise consult ABB regarding suitable grease.

Grease with the correct properties is available from all the major lubricant manufacturers.

Admixtures are recommended, but a written guarantee must be obtained from the lubricant manufacturer, especially concerning EP admixtures, that admixtures do not damage bearings or the properties of lubricants at the operating temperature range.

WARNING
Lubricants containing EP admixtures are not recommended in high bearing temperatures in frame sizes 280 to 450.

The following high performance greases can be used:

- Esso Unirex N2 or N3 (lithium complex base)
- Mobil Mobilith SHC 100 (lithium complex base)
- Shell Gadus S5 V 100 2 (lithium complex base)
- Klüber Klüberplex BEM 41-132 (special lithium base)
- FAG Arcanol TEMP110 (lithium complex base)
- Lubcon Turmogrease L 802 EP PLUS (special lithium base)
- Total Multiplex S 2 A (lithium complex base)

NOTE!
Always use high speed grease for high speed 2-pole machines where the speed factor is higher than 480,000 (calculated as $D_m \times n$ where D_m = average bearing diameter, mm; n = rotational speed, r/min).
The high speed grease is also used in motor types M2CA, M2FA, M2CG and M2FG, frame sizes 355 to 400 2-pole machines.

The following greases can be used for high speed cast iron motors but not mixed with lithium complex greases:

- Klüber Klüber Quiet BQH 72-102 (polyurea base)
- Lubcon Turmogrease PU703 (polyurea base)

If other lubricants are used;

Check with the manufacturer that the qualities correspond to those of the above mentioned lubricants. The lubrication interval are based on the listed high performance greases above. Using other greases can reduce the interval.

If the compatibility of the lubricant is uncertain, contact ABB.

[Click here to download](#)



[Table of contents](#)

[< Back](#)

[Tips](#)

[FAQs](#)

[Next >](#)

12/70

Tips

3. Wrong lubricant

Do not mix different types of grease.

Incompatible lubricants may cause bearing damage.



[Table of contents](#)

[< Back](#)

[Technical](#)

[FAQs](#)

[Next >](#)

13/70

FAQ

3. Wrong lubricant

Are there any specific greases I need to use in specific applications?

Yes, there are specific greases you need to use for say high temperature or hygienic applications....
...refer to the lubricants section of your motor operation manual.



[Table of contents](#)

[< Back](#)

[Technical](#)

[Tips](#)

[Next >](#)

14/70

Reasons why 51% of motors fail through bearings

4. Misalignment

It's essential that the motor and load be correctly aligned under actual operating temperatures and conditions. Machines that are correctly aligned at room temperature may become badly misaligned due to deformation or different thermal growth associated with temperature change. The alignment must be checked, and corrected, if necessary, after the motor and driven machine have reached their maximum temperature under load.

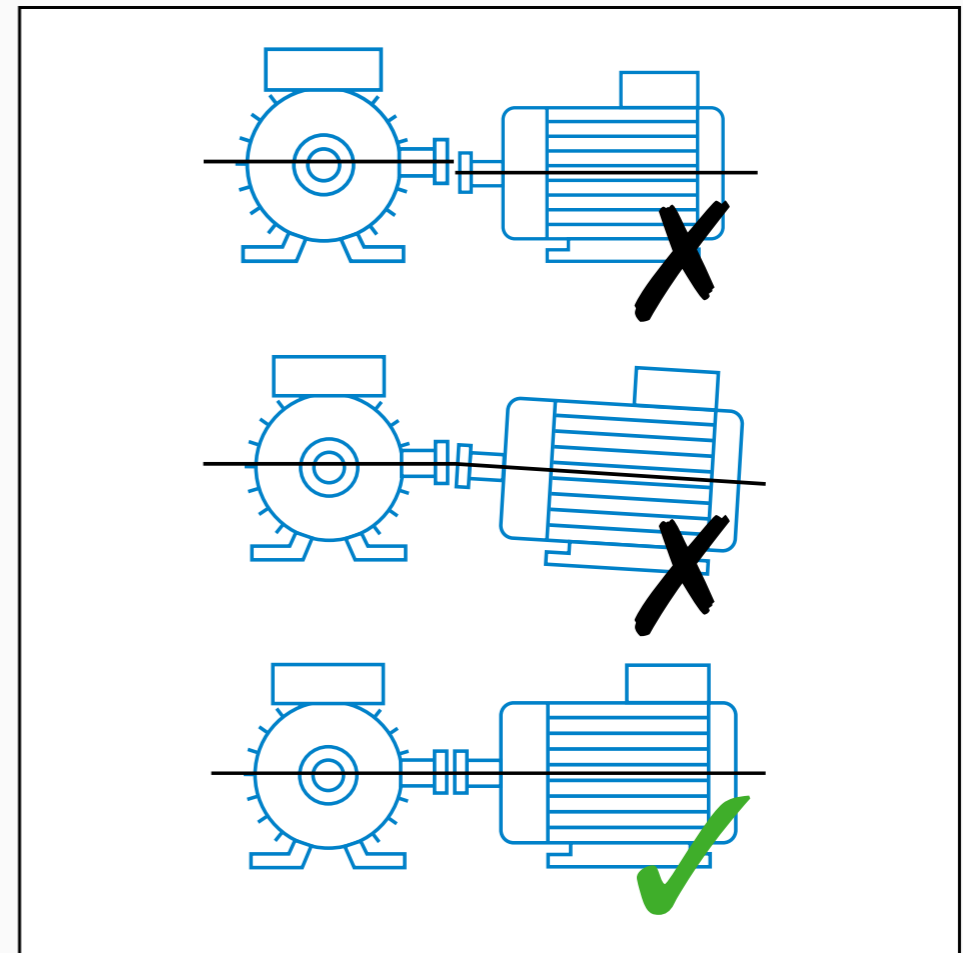

[Table of contents](#)

[< Back](#)

[Technical](#)

[Tips](#)

[FAQs](#)

[Next >](#)

15/70

Technical

4. Misalignment

Soft foot is one of the main causes of misalignment.

The 2 types of Soft Foot are:

- Angular Soft Foot
- Parallel Soft Foot

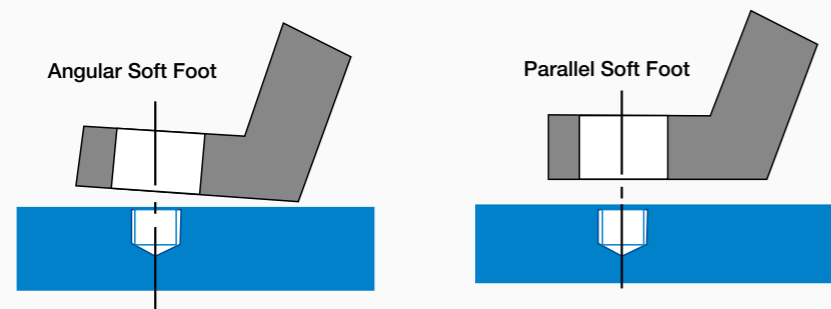

Common Causes of Soft Foot:

- Bent or deformed shim
- Bolt hole with a burr
- Bent motor foot
- Deformed machine base



[Table of contents](#)

[< Back](#)

[Tips](#)

[FAQs](#)

[Next >](#)

16/70

Tips

4. Misalignment

When torqueing the holding-bolts of your motor, use a cross-torque pattern to ensure an even secure fit.

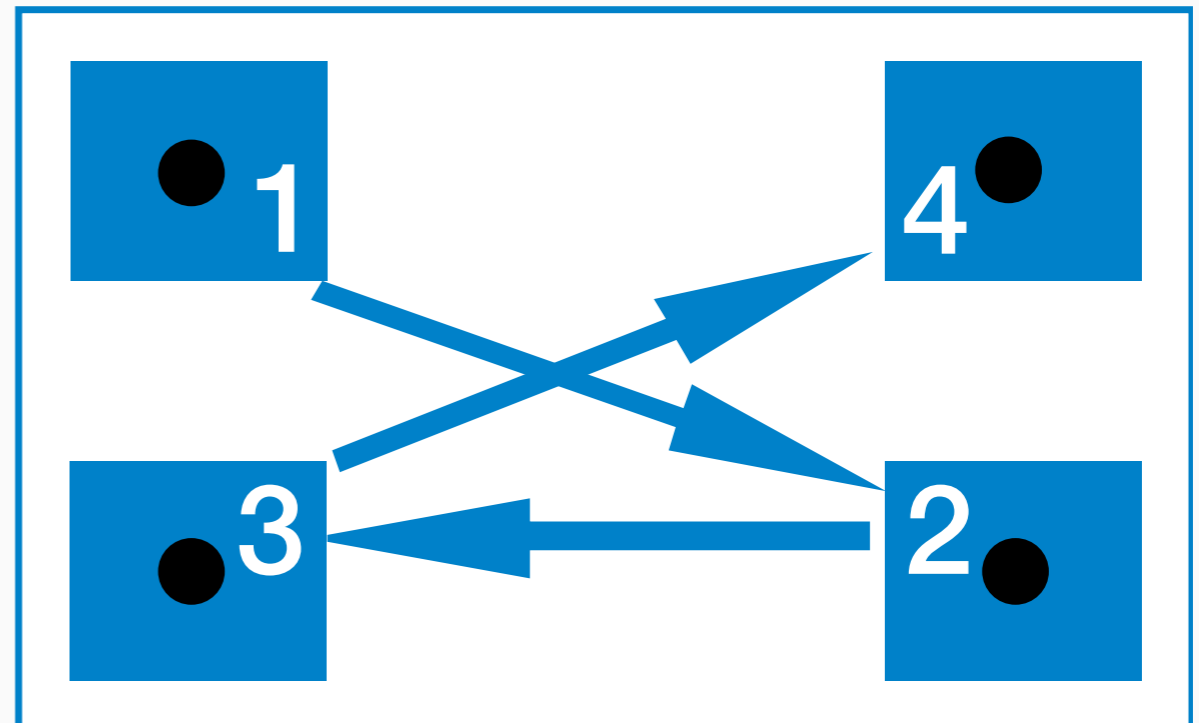

[Table of contents](#)

[< Back](#)

[Technical](#)

[FAQs](#)

[Next >](#)

17/70

FAQ

4. Misalignment

How often should I check the alignment of a motor?

ABB technicians recommend a motor should be checked approximately every 2,000 hours.

Both operating and non-operating alignment should be checked.



[Table of contents](#)

[< Back](#)

[Technical](#)

[Tips](#)

[Next >](#)

18/70

Reasons why 51 % of motors fail through bearings

5. Shaft overload

Excessive loading through the shaft of your motor may cause failure.

Belt driven pulleys often put high load directly onto the shaft bearing.



[Table of contents](#)

[< Back](#)

[Technical](#)

[Tips](#)

[FAQs](#)

[Next >](#)

19/70

Technical

5. Shaft overload

Pulley diameter

When the desired bearing life has been determined, the minimum permissible pulley diameter can be calculated with FR as follows:

$$D = \frac{1.9 \cdot 10^7 \cdot K \cdot P}{n \cdot F_R}$$

Where:

- D:** pulley diameter, mm
- P:** power requirement, kW
- n:** motor speed, r/min.
- K:** belt tension factor, dependent on belt type and type of duty. A common value for V-belts is 2.5
- F_R:** permissible radial force

Radial forces

Pulley diameter

When the desired bearing life has been determined the minimum permissible pulley diameter can be calculated with FR, according to the formula:

$$D = \frac{1.9 \cdot 10^7 \cdot K \cdot P}{n \cdot F_R}$$

Where:
D: pulley diameter, mm
P: power requirement, kW
n: motor speed, r/min.
K: belt tension factor, dependent on belt type and type of duty. A common value for V-belts is 2.5
F_R: permissible radial force

Permissible loading on shaft

The tables give the permissible radial force in Newtons, assuming zero axial force, ambient temperature of 25°C.

Permissible loads of simultaneous radial and axial forces will be supplied on request.

The bearing life, L_{10h}, is calculated according to SKF's theory on bearing life L_{10h}, which also takes the purity of the grease into consideration. An adequate lubrication is a necessary prerequisite for the table at right.

If the radial force is applied between points X₀ and X_{max}, the permissible force F_R can be calculated from the following formula:

$$F_R = F_{R0} \cdot \frac{X}{E} (F_{R0} - F_{Rmax})$$

Where:
E: length of the shaft extension in the standard version

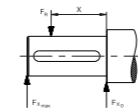

Radial forces

Pulley diameter

When the desired bearing life has been determined, the minimum permissible pulley diameter can be calculated with FR as follows:

$$D = \frac{1.9 \cdot 10^7 \cdot K \cdot P}{n \cdot F_R}$$

Where:
D: pulley diameter, mm
P: power requirement, kW
n: motor speed, r/min.
K: belt tension factor, dependent on belt type and type of duty. A common value for V-belts is 2.5
F_R: permissible radial force

Permissible radial forces, motor sizes 71 – 132

Motor size	No. of poles	Length of shaft extension E (mm)	Basic design with deep groove ball bearings	
			20,000 h	40,000 h
			F _{R0} (N)	F _{Rmax} (N)
71	2	30	540	460
	4	30	680	540
	6	30	792	655
80	2	40	735	620
	4	40	925	780
	6	40	1090	885
90	2	50	895	680
	4	50	1015	835
	6	50	1160	955
100	2	60	1060	780
	4	60	1240	940
	6	60	1410	1135
112	2	80	1280	1050
	4	80	1470	1215
	6	80	1685	1410
132	2	80	1720	1400
	4	80	2020	1690
	6	80	2320	1990

Permissible loading on the shaft
 The following table shows permissible radial forces on the shaft in Newtons, assuming zero axial force, a 25 °C ambient temperature, and normal conditions. The values are given for a calculated bearing life of 20 000 and 40 000 hours per motor size.

These calculated values further assume mounting position IM B3 (foot-mounted), with force directed sideways. In some cases, the strength of the shaft affects permissible forces.

Permissible loads of simultaneous radial and axial forces can be supplied on request.

If the radial force is applied between points X₀ and X_{max}, the permissible force FR can be calculated with the following formula:

$$F_R = F_{R0} \cdot \frac{X}{E} (F_{R0} - F_{Rmax})$$

Where:
E: length of the shaft extension in the standard version

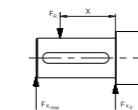

[Click here to download](#)

[Click here to download](#)



[Table of contents](#)

[< Back](#)

[Tips](#)

[FAQs](#)

[Next >](#)

Tips

5. Shaft overload

For motors in frame sizes 160 and above, on belt driven applications fit roller bearings.

Power and productivity for a better world™ **ABB**

Variant code: 037
Roller bearing at D-end.

This changes the drive end (D-end) ball bearing to a roller bearing. Roller bearings are used to accommodate high radial forces on applications such as belt drives. Roller bearings are not able to accommodate axial forces and in vertical applications may require special bearings to be fitted to the non-drive end. The shaft must also be checked to ensure that it can cope with the radial forces that will be applied to it. This check can be done using the Bearings program that comes included with the ABB DriveSize software.

This includes VC036 (transport lock for bearing) and VC041 (bearings regreassable via grease nipples) on 160 - 450 frame sizes.

Roller Bearing



Roller bearing with brass holder Roller bearing with polymer holder

Pictures of roller bearings, with brass holder (left) and polymer holder at (right). As a roller bearing is made up of an inner ring, outer ring and rolling elements in a holder they have a larger radial load carrying area compared to ball bearings. Roller bearings do not have a surface area to accommodate axial forces.

We reserve all rights in this document and in the subject matter and illustrations contained therein.
Any reproduction, disclosure to third parties or utilization of its contents - in whole or in parts - is forbidden without prior written consent of ABB.
Copyright© 2014 ABB

[Click here to download](#)



[Table of contents](#)

[< Back](#)

[Technical](#)

[FAQs](#)

[Next >](#)

21/70

FAQ

5. Shaft overload

How do I tell if an existing motor is suffering from shaft overload?

Rapid wear of belts is a simple visual sign of an overloaded shaft.

Check how often your belts are bottoming out - if it is happening a lot – shaft overload could be the cause.

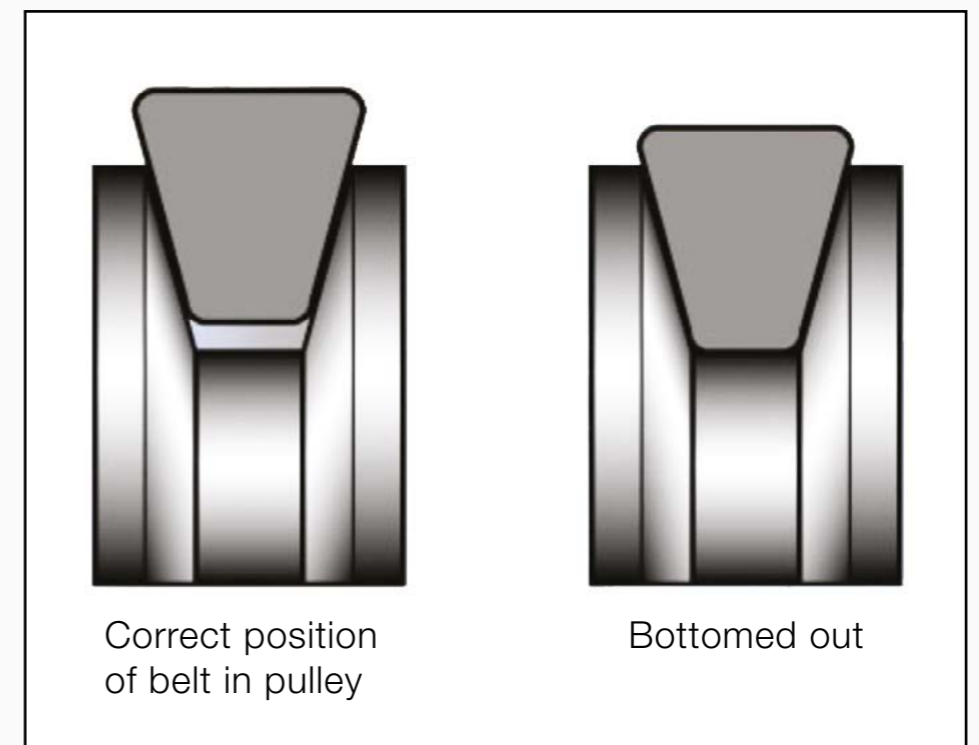

[Table of contents](#)

[< Back](#)

[Technical](#)

[Tips](#)

[Next >](#)

22/70

Reasons why 51 % of motors fail through bearings

6. Vibration

Excessive vibration can also lead to premature bearing failure.

Check motor mounting bolts are secure as vibration may cause them to become loose during operation.



[Table of contents](#)

[< Back](#)

[Technical](#)

[Tips](#)

[FAQs](#)

[Next >](#)

23/70

Technical

6. Vibration

Motor vibration causes can be:

- Electromagnetic
- Mechanical imbalance
- Rubbing parts
- Bearing failure
- Resonance

Measure vibration on all 3 planes:

- Vertical
- Horizontal
- Axial

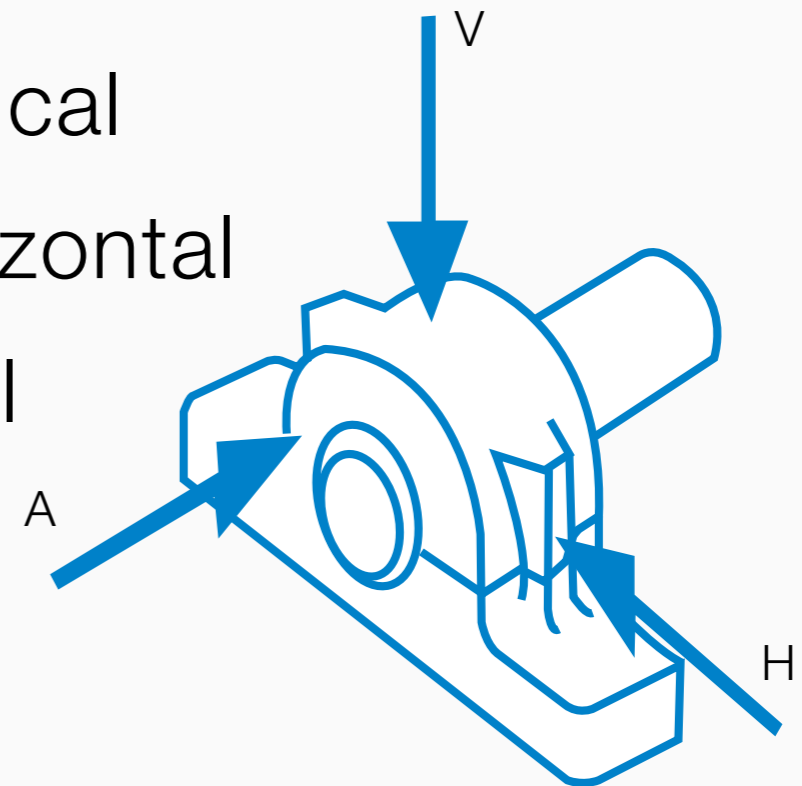

Tips

6. Vibration

Vibration causes are often in one of two areas:

- Shaft vibration
- Housing vibration

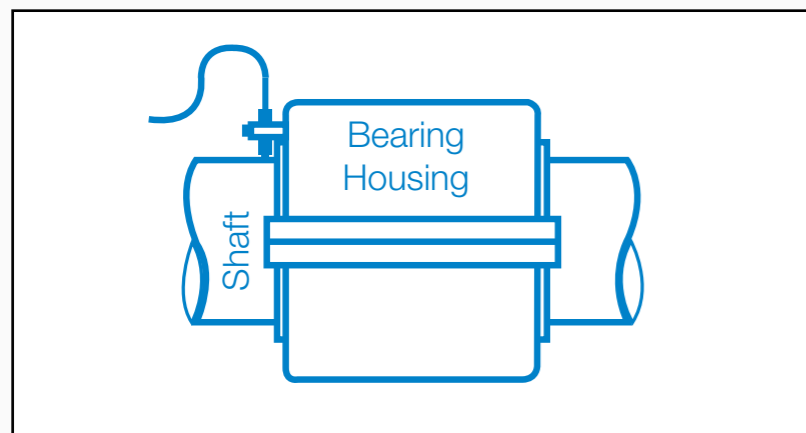

Check vibrations with a combination of:

- Magnetic accelerometers (ensure they are mounted correctly)
- Proximity probes (commonly known as Eddy probes)

FAQ

6. Vibration

How do I tell if the vibration on my motor is normal?

Stringent specifications for Motor vibration call for:

- A maximum velocity level of 0.1 in./sec on the housing
- 1.5 mm of displacement vibration on the shaft

Refer to the Vibration Severity tolerances set out by ISO 10816 for guidance.

VIBRATION SEVERITY PER ISO 10816						
	Machine		Class I small machines	Class II medium machines	Class III large rigid foundation	Class IV large soft foundation
	in/s	mm/s				
Vibration Velocity Vrms	0.01	0.28				
	0.02	0.45				
	0.03	0.71		good		
	0.04	1.12				
	0.07	1.80				
	0.11	2.80		satisfactory		
	0.18	4.50				
	0.28	7.10		unsatisfactory		
	0.44	11.2				
	0.70	18.0				
	0.71	28.0		unacceptable		
1.10	45.0					



Table of contents

< Back

Technical

Tips

Next >

26/70

Reasons why 51% of motors fail through bearings

7. Over-heating

Make sure your motor is designed to cope with the heat it is subjected to...

Bearings have different clearances to allow for thermal expansion in operation.



[Table of contents](#)

[< Back](#)

[Technical](#)

[Tips](#)

[FAQs](#)

[Next >](#)

27/70

Technical

7. Over-heating

Keep an eye on your bearing temperature... and ensure you use the correct grease for high temperature applications. See the ABB guides...

Power and productivity
for a better world™ **ABB**

Variant code: 040
Heat resistant grease.

This is to be used in order to prolong the re-greasing interval on re-greaseable motors as well as prolonging the lifetime of sealed bearings.

By using this, the re-greasing interval / bearing lifetime (sealed bearings) can be doubled compared to standard grease.

For every +15C increase of bearing temperature (ambient) the lifetime / re-greasing interval should be halved.

When the heat resistant grease option is ordered re-greaseable motors are provided with Küber Quiet BQH 72-102 grease.

We reserve all rights in this document and in the subject matter and illustrations contained therein.
Any reproduction, disclosure to third parties or utilization of its contents - in whole or in parts - is forbidden without prior written consent of ABB.
Copyright 2014 ABB

[Click here to download](#)

Power and productivity
for a better world™ **ABB**

Variant code: 107 Pt100 2-wire in bearings

This includes a Pt100 temperature measuring sensor with 2 wires. Pt100 is installed to measure the temperature of bearings. Resistance varies linearly with temperature.

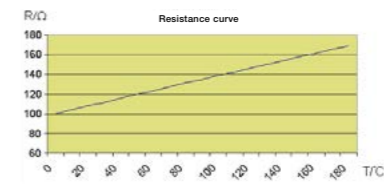

Figure 1. Resistance-Temperature characteristic.

Other variant codes related to this code:	
Code	Name
130	Pt100 3-wire in bearings
420	Bearing mounted PTC thermistors

We reserve all rights in this document and in the subject matter and illustrations contained therein.
Any reproduction, disclosure to third parties or utilization of its contents - in whole or in parts - is forbidden without prior written consent of ABB.
Copyright 2014 ABB

[Click here to download](#)



[Table of contents](#)

[< Back](#)

[Tips](#)

[FAQs](#)

[Next >](#)

Tips

7. Over-heating

For every 15°C cooler you typically double the re-greasing interval / bearing life!

Keeping the motor operating environment as cool as possible will greatly increase motor life.



[Table of contents](#)

[< Back](#)

[Technical](#)

[FAQs](#)

[Next >](#)

29/70

FAQ

7. Over-heating

How do I tell if the motor bearings are overheating?

Use a temperature probe or thermal imaging camera to test bearing temperature.

Make sure the readings are within the tolerances of the installed bearing.



[Table of contents](#)

[< Back](#)

[Technical](#)

[Tips](#)

[Next >](#)

30/70

Stator winding failure

The facts

16% of motor failures are
stator winding related*

*Based on IEA data



[Table of contents](#)

[< Back](#)

[Next >](#)

31/70

Reasons why 16% of motors fail due to stator winding failure

1. Over-heating...

The cooler the motor operates, the longer its expected life...

A 10°C reduction in operating temperature typically doubles the motors lifetime.



[Table of contents](#)

[< Back](#)

[Technical](#)

[FAQs](#)

[Next >](#)

32/70

Technical

1. Over-heating

Excessive starts are a major cause of over-heating.

During start-up a motor typically sees between 6 to 8 times its rated current.

This increases the thermal status of the motor, increases thermal stress on the windings and can cause failure.

PTC Thermistors are a common protection method to protect against over-heating.

Thermistors have a positive temperature coefficient meaning that the resistance is increasing rapidly around the trip temperature. Connected to a thermistor relay this will trip preventing over-heating. Normal operating conditions will not cause this to happen.

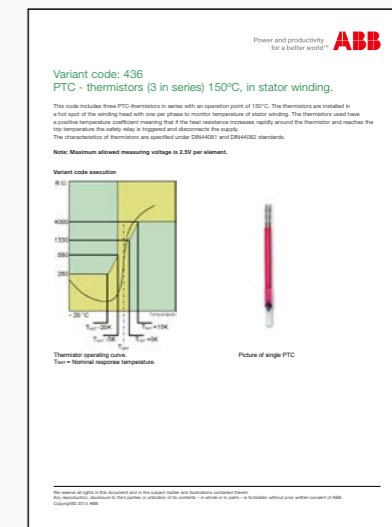

[Click here to download](#)



[Table of contents](#)

[< Back](#)

[FAQs](#)

[Next >](#)

FAQ

1. Over-heating

How do I tell if the windings on a motor are under thermal stress?

Look for darkened areas on the motor windings – these marks are signs of over-heating.



Reasons why 16% of motors fail due to stator winding failure

2. Over-loading

Motor windings can fail due to over-loading at the motor shaft which causes excessive heat build-up and failure.

Fit thermal thermistor protection to guard against failure.



[Table of contents](#)

[< Back](#)

[Technical](#)

[Tips](#)

[Next >](#)

35/70

Technical

2. Over-loading

A thermal overload relay is a common protection method used to protect against over-load. It is a bimetallic strip that bends when over-loaded due to heat build up.

Normal operating currents will not cause this to happen.



[Table of contents](#)

[< Back](#)

[Tips](#)

[Next >](#)

36/70

Tips

2. Over-loading

Connect thermistors to a thermistor relay in the motor control package and set the current overload limits to the rating plate FLC.

Follow manufacturer manuals for correct installation and limits for your motor.



[Table of contents](#)

[< Back](#)

[Technical](#)

[Next >](#)

37/70

External conditions failure

The facts

16% of motor failures are due to
external factors*

*Based on IEA data



[Table of contents](#)

[< Back](#)

[Next >](#)

38/70

Reasons why 16% of motor failures are due to external conditions

1. Motor operating temperature

The industry standard for LV motor insulation systems is class F, with a limit on temperature rise of class B.

Other insulation systems offering higher levels of protection are available. Ask your ABB contact or ABB authorized value provider.



[Table of contents](#)

[< Back](#)

[Tips](#)

[Next >](#)

39/70

Tips

1. Motor operating temperature

Ensure that the cooling systems of the motor are suitably maintained.

Broken fans, clogged vents and blocked or damaged cooling fins can cause excessive heat build-up.

Check motor cooling regularly.



[Table of contents](#)

[< Back](#)

[Next >](#)

40/70

Reasons why 16% of motor failures are due to external conditions

2. Humidity & Environment

Electricity and water are a bad mix; high humidity can allow moisture to enter the motor and cause damage and corrosion.



[Table of contents](#)

[< Back](#)

[Technical](#)

[Tips](#)

[FAQs](#)

[Next >](#)

41/70

Technical

2. Humidity & Environment

This can be combatted by.....

- Opening drain hole plugs
- Fitting anti condensation heaters
- Utilizing addition corrosion protection
- Enhanced paint systems



[Click here to download](#)

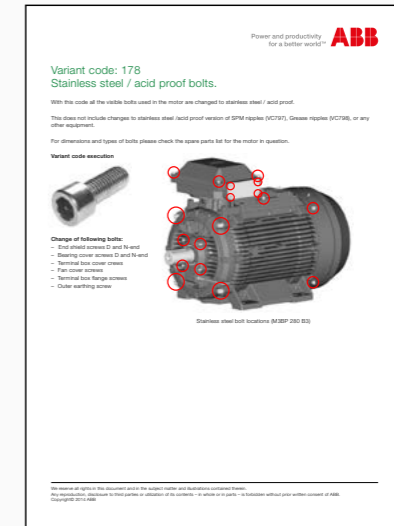

[Click here to download](#)

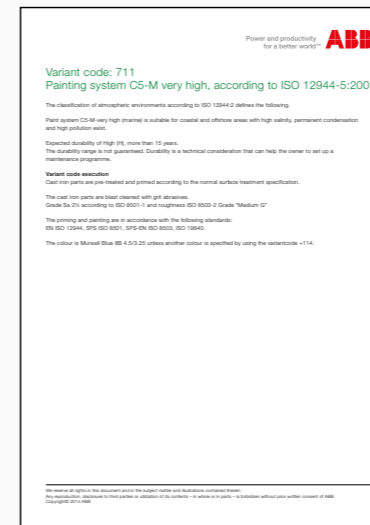

[Click here to download](#)

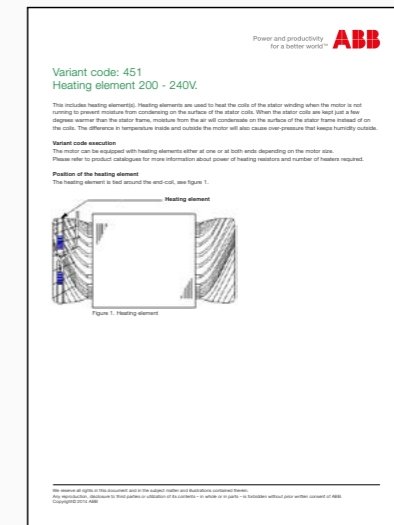

[Click here to download](#)



[Table of contents](#)

[< Back](#)

[Tips](#)

[FAQs](#)

[Next >](#)

Tips

2. Humidity & Environment

Where motors are operating in harsh outdoor conditions, consider the effects of cold as well as heat.

Condensation heaters should be fitted to motors used outdoor in cold winter months to minimise condensation within the motor.



[Table of contents](#)

[< Back](#)

[Technical](#)

[FAQs](#)

[Next >](#)

43/70

FAQ

2. Humidity & Environment

What do I do if I can't seal completely against moisture ingress?

Ensure that breather plugs are fitted and are kept clear – this will ensure any moisture that does enter can drain away.



[Table of contents](#)

[< Back](#)

[Technical](#)

[Tips](#)

[Next >](#)

44/70

Reasons why 16% of motor failures are due to external conditions

3. Contamination

Ingress of foreign particles into the motor enclosure can cause damage - particularly to a motors bearings or windings.

Use the correct IP ratings to protect your motor.



[Table of contents](#)

[< Back](#)

[Technical](#)

[Tips](#)

[FAQs](#)

[Next >](#)

45/70

Technical

3. Contamination

Motor IP ratings explained...

3.5 Degrees of protection: IP code/IK code

Classifications of the degrees of protection provided by enclosures of rotating machines are based on:

- IEC / EN 60034-5 or IEC / EN 60529 for IP code
- EN 50102 for IK code

IP protection:

Protection of persons against getting in contact with (or approaching) live parts and against contact with moving parts inside the enclosure. Also protection of the machine against the ingress of solid foreign objects. Protection of machines against the harmful effects of the ingress of water.

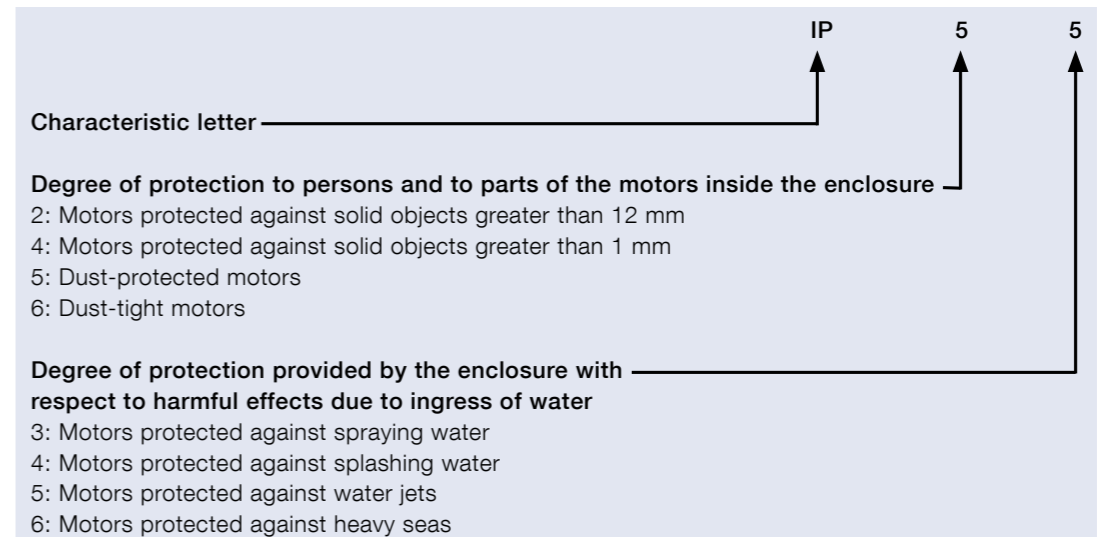

Refer to the ABB LV Motor Guide for more details



Table of contents

< Back

Tips

FAQs

Next >

46/70

Tips

3. Contamination

Other basic measures to protect your motors against ingress are...

- Labyrinth seals
- Radial seals
- Using IP56 or IP65 rated motors

Power and productivity **ABB**
for a better world™

Variant code: 072
Radial seal at D-end (for 2-pole 280 and 315).

A radial seal is mainly used to prevent oil, water or other liquid (or dust) entering into the motor.

Important: This option is suitable for oil or water splash only. In cases of presence of water it is important to make sure that the seal is lubricated. If the motor shaft will be under constant exposure to oil please use variant code 073. If there will be constant exposure to water please consult your ABB office.

The radial seal is more suitable for motors with smaller shaft diameters as a bigger shaft diameter will increase the angle toward the speed of a rotor on the horizontal when the shaft rotates. The radial seal prevents ingress of foreign bodies by maintaining in constant contact with the shaft of the motor. An increase in the angle of speed leads to higher friction between the shaft and the seal and increases the seal temperature. This shortens the life of the seal and in the result why the radial seal is not suitable for 2-pole 280 and 315 frames as well as 355 frames or larger. A radial shaft seal also always needs to be greased and should never be allowed to run dry.

Variant code execution



We reserve all rights in this document and in the subject matter and disclaim any liability. This document is approved for IP56 protection or equivalent of customer's choice or grade 10 insulation without prior written consent of ABB. Copyright 2015 ABB.

[Click here to download](#)

Power and productivity **ABB**
for a better world™

Variant code:
783 Labyrinth sealing at D-end

The labyrinths prevent water from penetrating into the motor along the shaft. The protection class of the labyrinth seal is IP56. Labyrinth sealing is recommended for all motors used outdoors with a shaft end being upwards.



We reserve all rights in this document and in the subject matter and disclaim any liability. This document is approved for IP56 protection or equivalent of customer's choice or grade 10 insulation without prior written consent of ABB. Copyright 2015 ABB.

[Click here to download](#)

Power and productivity **ABB**
for a better world™

Variant code:
158 Degree of protection IP65.

This includes degree of protection IP56. With this code a motor is protected according to IEC 60034-5 or EN 60033.

Definition of IP56

Characteristic letters: **IP 5 6**

First characteristic numeral (see table 1): **5**
Second characteristic numeral (see table 2): **6**

First characteristic numeral	Brief description	Degree of protection
5	Dust-tight enclosure	Ingress of dust totally prevented

Table 1: Definition of First characteristic numeral

Second characteristic numeral	Brief description	Degree of protection
6	Machine protected against water jet	Water protected by a nozzle against the machine from any direction shall have no harmful effect

Table 2: Definition of Second characteristic numeral

Other variant codes related to this code:

Code	Name
074	Degree of protection IP55
157	Terminal box degree of protection IP55
211	Weather protected, IP to W
403	Degree of protection IP56, without fan and fan cover
404	Degree of protection IP56, without fan and fan cover
404	Degree of protection IP56, open deck

We reserve all rights in this document and in the subject matter and disclaim any liability. This document is approved for IP56 protection or equivalent of customer's choice or grade 10 insulation without prior written consent of ABB. Copyright 2015 ABB.

[Click here to download](#)

Power and productivity **ABB**
for a better world™

Variant code:
403 Degree of protection IP56.

This includes degree of protection IP56. With this code a motor is protected according to IEC 60034-5 or EN 60033.

Definition of IP56

Characteristic letters: **IP 5 6**

First characteristic numeral (see table 1): **5**
Second characteristic numeral (see table 2): **6**

First characteristic numeral	Brief description	Degree of protection
5	Dust-protected machine	Contact with or approach to live or moving parts inside the enclosure

Table 1: Definition of First characteristic numeral

Second characteristic numeral	Brief description	Degree of protection
6	Machine protected against heavy water jet	Water from heavy water jet shall not enter the machine in normal quantities

Table 2: Definition of Second characteristic numeral

Other variant codes related to this code:

Code	Name
074	Degree of protection IP55
157	Terminal box degree of protection IP55
158	Degree of protection IP55
211	Weather protected, IP to W
404	Degree of protection IP56, without fan and fan cover
404	Degree of protection IP56, open deck

We reserve all rights in this document and in the subject matter and disclaim any liability. This document is approved for IP56 protection or equivalent of customer's choice or grade 10 insulation without prior written consent of ABB. Copyright 2015 ABB.

[Click here to download](#)



[Table of contents](#)

[< Back](#)

[Technical](#)

[FAQs](#)

[Next >](#)

FAQ

3. Contamination

What about protection against mechanical impacts?

IK codes outline the degree of protection of a motor against external mechanical impact.

International mechanical protection IK 05

Characteristic group

Relation between IK code and impact energy:

IK code	IK 00	IK 01	IK 02	IK 03	IK 04	IK 05	IK 06	IK 07	IK 08	IK 09	IK 10
Impact	*	0.15	0.2	0.35	0.5	0.7	1	2	5	10	20
Energy									ABB standard		
Joule											

* not protected according to EN 50102

Refer to the ABB LV Motor Guide for more details



Table of contents

< Back

Technical

Tips

Next >

Reasons why 16% of motor failures are due to external conditions

4. Ambient temperatures

Ensure motors are rated for the ambient condition in which they operate.

Derating is often necessary for high ambient temperatures whilst low ambients may require special materials.



[Table of contents](#)

[< Back](#)

[Technical](#)

[Tips](#)

[FAQs](#)

[Next >](#)

49/70

Technical

4. Ambient temperatures

Check your motor is suited to its operating environment...

Power and productivity **ABB**
for a better world™

Variant code:
398 Motor designed for ambient temperature -20°C to -40°C.

This includes motors designed for use in ambient temperatures from -20°C to -40°C. For more information see 3C2F50090-39 for EasA motors and 3C2F50090-40 for EasE motors.

Other variant codes related to this code:

Code	Name
396	Motor designed for ambient temperature -20°C to -40°C, with space heaters (code 450/451 must be added)
397	Motor designed for ambient temperature -40°C to -55°C, with space heaters (code 450/451 must be added)
399	Motor designed for ambient temperature -40°C to -55°C

We reserve all rights in this document and in the subject matter and illustrations contained therein. Any reproduction, disclosure to third parties or utilization of its contents - in whole or in parts - is forbidden without prior written consent of ABB. Copyright 2014 ABB

Power and productivity **ABB**
for a better world™

Variant code: 068
Light alloy metal fan.

ABB uses plastic or glass fiber re-reinforced plastic fans as standard. As an alternative to that a fan made in aluminum alloy is also offered. For applications where the ambient temperature is below -20°C or over +55°C this is mandatory low temperature makes the fan fragile and high temperature makes the soft wings bend. Also for speed higher than the nominal speed of the standard motor (in variable-speed drive applications) it might be necessary to change the fan. The maximum allowed fan speed for each motor type can be defined with the help of Direct3D program.

Example of fans

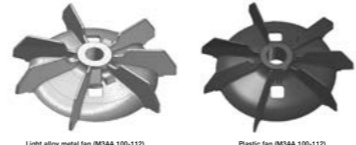

Light alloy metal fan (MSAA 100-112) **Plastic fan (MSAA 100-112)**

We reserve all rights in this document and in the subject matter and illustrations contained therein. Any reproduction, disclosure to third parties or utilization of its contents - in whole or in parts - is forbidden without prior written consent of ABB. Copyright 2014 ABB

Power and productivity **ABB**
for a better world™

Variant code:
399 Motor designed for ambient temperature -40°C to -55°C.

This includes motors designed for use in ambient temperatures from -40°C to -55°C. For more information see 3C2F50090-39 for EasA motors and 3C2F50090-40 for EasE motors.

Other variant codes related to this code:

Code	Name
396	Motor designed for ambient temperature -20°C to -40°C, with space heaters (code 450/451 must be added)
397	Motor designed for ambient temperature -40°C to -55°C, with space heaters (code 450/451 must be added)
398	Motor designed for ambient temperature -20°C to -40°C

We reserve all rights in this document and in the subject matter and illustrations contained therein. Any reproduction, disclosure to third parties or utilization of its contents - in whole or in parts - is forbidden without prior written consent of ABB. Copyright 2014 ABB

[Click here to download](#)

[Click here to download](#)

[Click here to download](#)



[Table of contents](#)

[< Back](#)

[Tips](#)

[FAQs](#)

[Next >](#)

50/70

Tips

4. Ambient temperatures

Basic motors are designed for operation in a maximum ambient temperature environment of 40° C and at a maximum altitude of 1000 meters above sea level.

If a motor is to be operated in higher ambient temperatures,

it should normally be derated, as a guide use the table below.

Ambient temperature, °C	30	40	45	50	55	60	70	80
Permitted output, % of rated output	107	100	95.5	93	90	80.5	79	70
Height above sea level, m	1000	1500	2000	2500	3000	3500	4000	
Permitted output, % of rated output	100	96	92	88	84	80	76	

Refer to the ABB LV Motor Guide for more details



[Table of contents](#)

[< Back](#)

[Technical](#)

[FAQs](#)

[Next >](#)

51/70

FAQ

4. Ambient temperatures

For more information about motor derating consult the ABB Motor Guide.

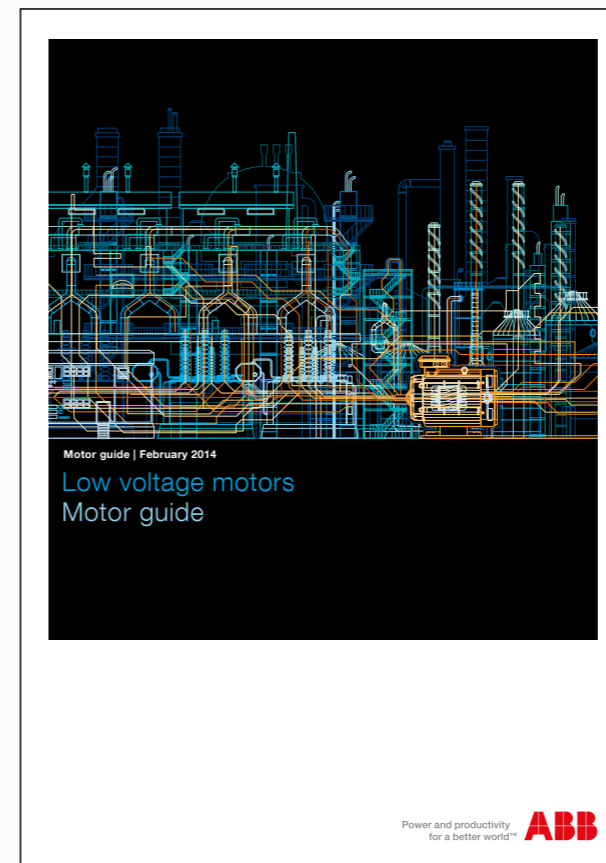

[Click here to download](#)



[Table of contents](#)

[< Back](#)

[Technical](#)

[Tips](#)

[Next >](#)

52/70

Rotor bar failure The facts

5% of motor failures are due to
rotor failures*

*Based on IEA data



[Table of contents](#)

[< Back](#)

[Next >](#)

53/70

Reasons why 5% of motor failures are due to the rotor bar

1. Excessive starting frequency

This puts high electro-mechanical stress on the rotor.

Heating, cooling, acceleration & deceleration can cause thermal stress and inertia fractures.



[Table of contents](#)

[< Back](#)

[Technical](#)

[Tips](#)

[Next >](#)

54/70

Technical

1. Excessive starting frequency

Starting time is a function of load torque, inertia and motor torque. As the starting current is always very much higher than the rated current, an excessively long starting period will cause a harmful temperature rise in the motor.

Consult the **ABB Motor Guide** for maximum starting times.

Maximum starting times (seconds) for occasional starting

Motor size	Starting method	Number of poles			
		2	4	6	8
56	D.O.L.	25	40	NA	NA
63	D.O.L.	25	40	NA	NA
71	D.O.L.	20	20	40	40
80	D.O.L.	15	20	40	40
90	D.O.L.	10	20	35	40
100	D.O.L.	10	15	30	40
112	D.O.L.	20	15	25	50
	Y/Δ	60	45	75	150
132	D.O.L.	15	10	10	20
	Y/Δ	45	30	30	60
160	D.O.L.	15	15	20	20
	Y/Δ	45	45	60	60
180	D.O.L.	15	15	20	20
	Y/Δ	45	45	60	60
200	D.O.L.	15	15	20	20
	Y/Δ	45	45	60	60
225	D.O.L.	15	15	20	20
	Y/Δ	45	45	60	60
250	D.O.L.	15	15	20	20
	Y/Δ	45	45	60	60
280	D.O.L.	15	18	17	15
	Y/Δ	45	54	51	45
315	D.O.L.	15	18	16	12
	Y/Δ	45	54	48	36
355	D.O.L.	15	20	18	30
	Y/Δ	45	60	54	90
400	D.O.L.	15	20	18	30
	Y/Δ	45	60	54	90
450	D.O.L.	15	20	18	30
	Y/Δ	45	60	54	90



Table of contents

< Back

Tips

Next >

55/70

Tips

1. Excessive starting frequency

When a motor is subjected to frequent starting, it cannot be loaded at its rated output due to the thermal starting losses in the windings.

Consult the **ABB Motor Guide** to calculate the permissible output power or Contact ABB.

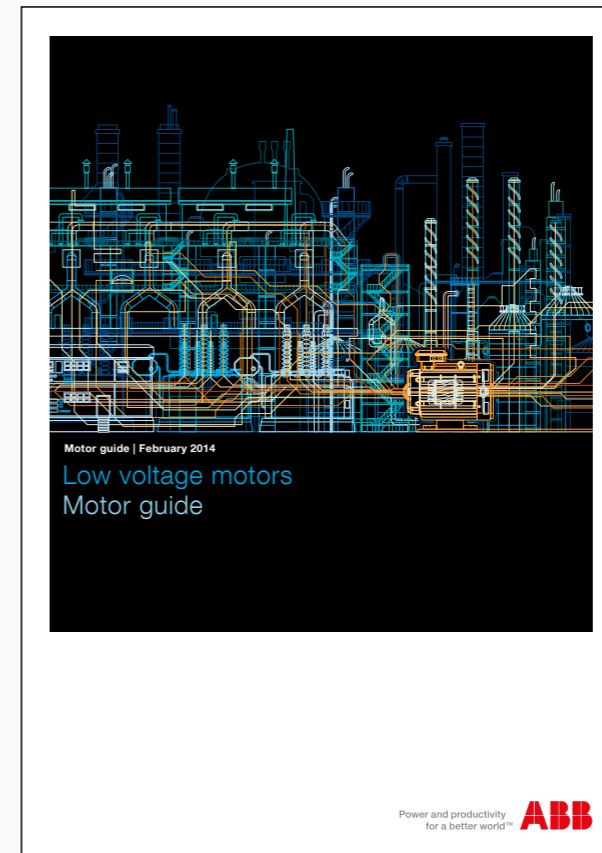

[Click here to download](#)



[Table of contents](#)

[< Back](#)

[Technical](#)

[Next >](#)

56/70

Reasons why 5% of motor failures are due to the rotor bar

2. Overloads

In a locked rotor or stall condition the rotor can experience sudden and excessive temperature rise that can cause the rotor cage to fail.



[Table of contents](#)

[< Back](#)

[Technical](#)

[Tips](#)

[FAQs](#)

[Next >](#)

57/70

Technical

2. Overloads

Sudden increases in temperature often occur during start-up.

High currents combined with low cooling air flows (low motor speed and small amount of air from the cooling fans)



[Table of contents](#)

[< Back](#)

[Tips](#)

[FAQs](#)

[Next >](#)

58/70

Tips

2. Overloads

Motors can stall during normal operation due to mechanical faults.

Seized bearings, heavy loading or foreign objects caught in an application could be the possible causes.

See the **Bearing Failure section** of this eBook for more information.



Table of contents

< Back

Technical

FAQs

Next >

59/70

FAQ

2. Overloads

How can I protect a motor from a stalled condition?

A stalling relay should be used. The most common type of stall protection uses a relay, which uses the principles of a standard thermal relay but operates faster.

By passing a portion of the motor current directly through bimetallic elements in the relay, heating is immediate, just as it would be experienced in the windings of the motor.

This makes the stalling relay act quickly to protect the motor.



[Table of contents](#)

[< Back](#)

[Technical](#)

[Tips](#)

[Next >](#)

60/70

Reasons why 5% of motor failures are due to the rotor bar

3. Under voltage

This increases running current, causes overheating and reduces efficiency - eventually causing failure.



[Table of contents](#)

[< Back](#)

[Next >](#)

61/70

Shaft coupling failure The facts

2% of motor failures are due to
the shaft coupling*

*Based on IEA data



[Table of contents](#)

[< Back](#)

[Next >](#)

62/70

Reasons why 2% of motor failures are due to shaft coupling

1. Misalignment

A coupling that is badly aligned suffers unusual load stresses and can lead to failure.

Ensure the coupling is aligned parallel to the shafts.



[Table of contents](#)

[< Back](#)

[Technical](#)

[Tips](#)

[FAQs](#)

[Next >](#)

63/70

Technical

1. Misalignment

Use the ABB MotSize Software to identify the correct coupling for your motor...

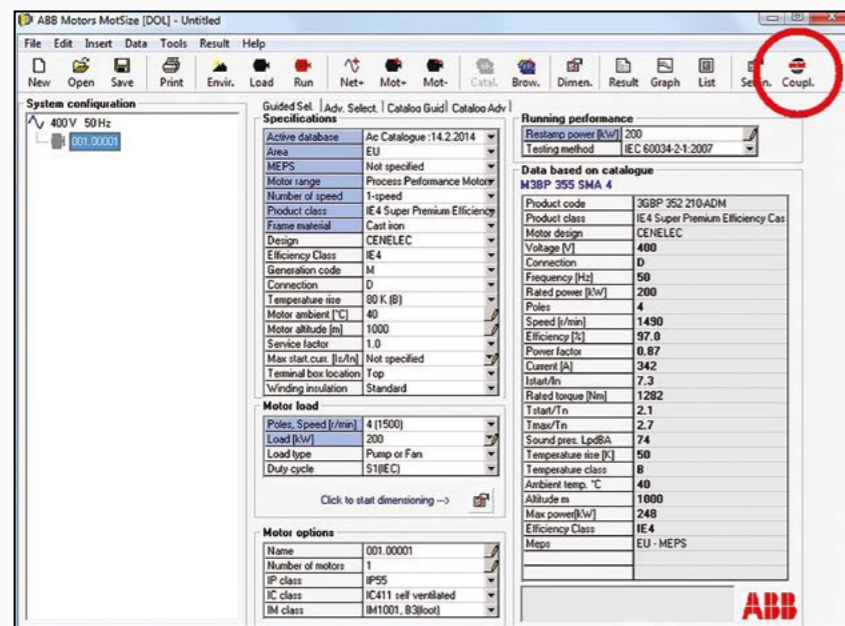

[Click here to download](#)



[Table of contents](#)

[< Back](#)

[Tips](#)

[FAQs](#)

[Next >](#)

Tips

1. Misalignment

Check all 3 types of alignment of your motor...

Mechanical alignment:

Experience has shown that any base-mounted assembly of motor and driven load, no matter how rugged or deep in section, may twist out of alignment during shipping or moving, and that alignment by eye is ineffective. Proper alignment of direct-coupled drives can be accomplished by a dial-indicator, laser, or computerised instrumentation.

Parallel misalignment:

This is the offset between the centrelines of the two shafts. This can be determined by mounting a dial indicator on one coupling half with the indicator probe bearing radially on the other coupling half, and then rotating both shafts together through 360 degrees.

Angular misalignment:

This is the amount by which the faces of the two coupling halves are out of parallel. This may be determined by mounting a dial indicator on one coupling half with the indicator probe on the face of the other half, and then rotating both shafts together through 360 degrees to determine any variation in reading. During this check, you must keep the shaft of a motor with endplay against its thrust shoulder and the shaft of a driven load with endplay against its thrust shoulder to prevent false readings due to shaft movements in the axial direction.



[Table of contents](#)

[< Back](#)

[Technical](#)

[FAQs](#)

[Next >](#)

65/70

FAQ

1. Misalignment

What is the best way to ensure my coupling is aligned correctly?

Laser alignment is the best way to ensure accurate alignment. Contact your coupling manufacturer for the alignment tolerances for your coupling.

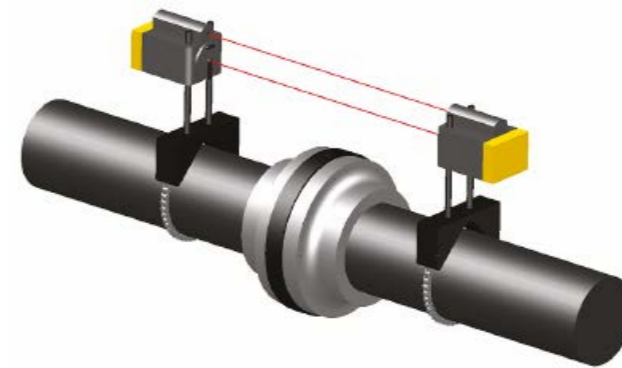

Reasons why 2% of motor failures are due to shaft coupling

2. Bad installation

The biggest cause of coupling failure is due to incorrect mounting.

Research and use appropriate fitting techniques for your motor.



[Table of contents](#)

[< Back](#)

[Technical](#)

[Tips](#)

[FAQs](#)

[Back to the start](#) 67/70

Technical

2. Bad installation

There are two main types of couplings available:

1. Rigid couplings – for use when shafts are coaxially aligned.
2. Flexible or compensating couplings – for use when shafts alignment cannot be guaranteed or there is expected distortion or movement that could be transmitted through the shaft.



[Table of contents](#)

[< Back](#)

[Tips](#)

[FAQs](#)

[Back to the start](#) 68/70

Tips

2. Bad installation

When installing a shaft coupling, ensure that you are using the correct coupling type.

If there is a degree of distortion or shock expected through the shaft, then a flexible coupling should be used.



[Table of contents](#)

[< Back](#)

[Technical](#)

[FAQs](#)

[Back to the start](#) 69/70

FAQ

2. Bad installation

Can rigid couplings be used on misaligned shafts?

Rigid couplings should not be used on misaligned shafts. Misalignment could generate lateral forces which could lead to premature failure of the shaft, bearings or couplings from wear and metal fatigue.



[Table of contents](#)

[< Back](#)

[Technical](#)

[Tips](#)

[Back to the start](#) 70/70